

CENTRAL LUBRICATION SYSTEMS FOR WIND CONVERTERS

- The ideal lubrication system for each application
- Innovative technology for efficient wear reduction
- Tried-and-tested components for highest operational reliability
- Also with electronic monitoring

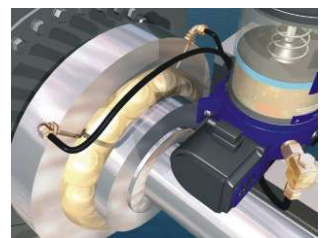

...made by

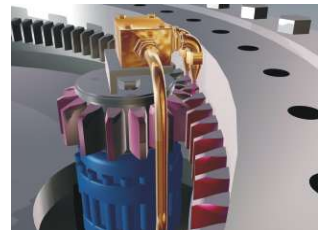
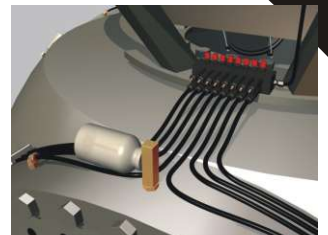

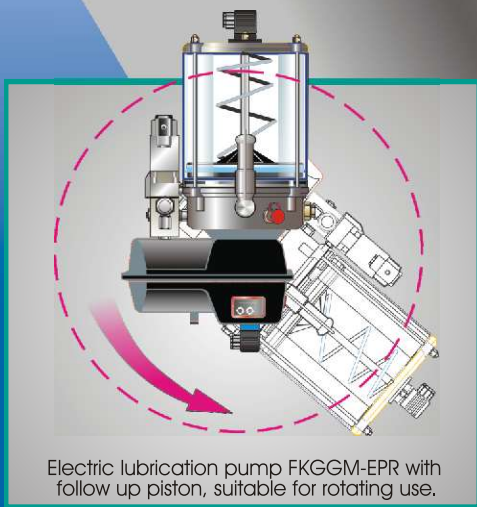

BEKAWIND SINGLE

The single line system

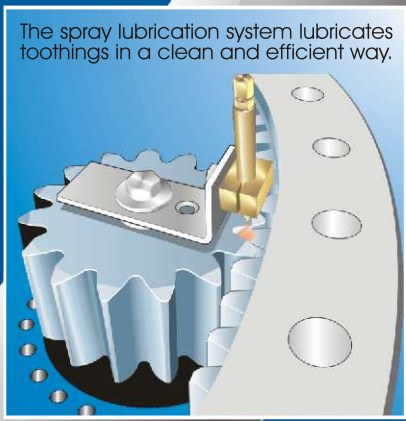

BEKAWIND FLOW

Spray lubrication system

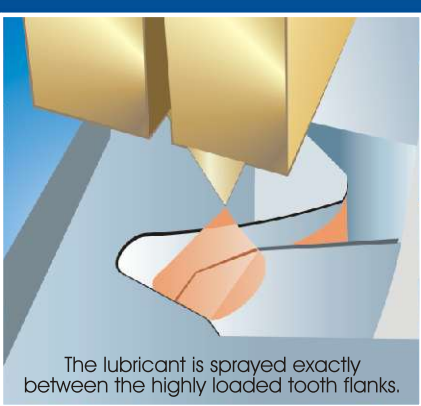
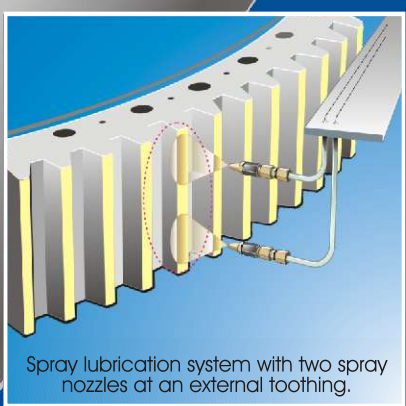

BEKAWIND COMBI The combined system

In the rotor hub, lubricant is forwarded to blade bearings and blade drives.

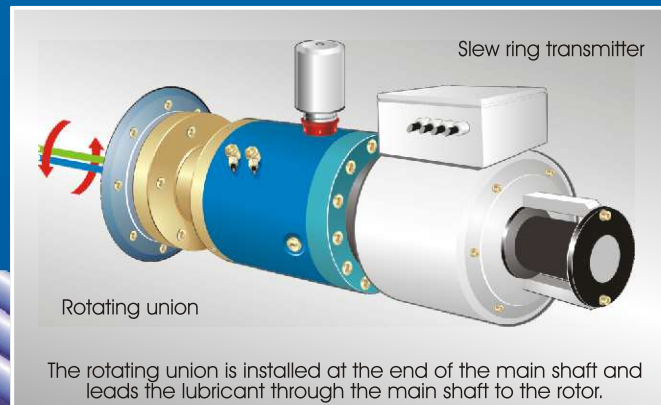
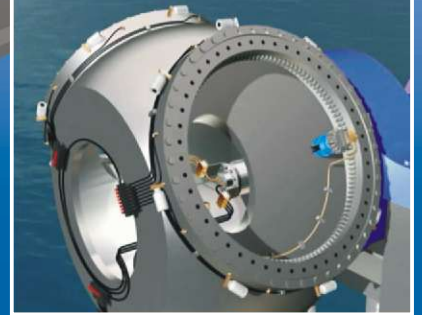

The whole lubricant supply is located in the nacelle.

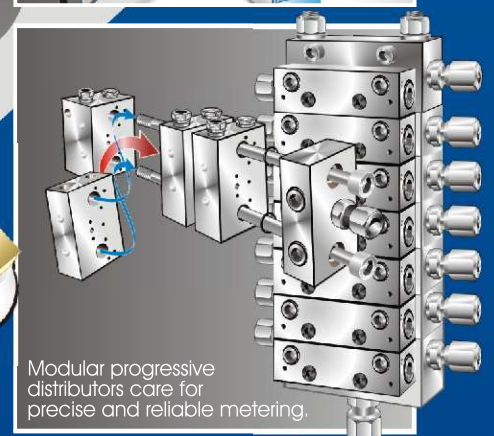
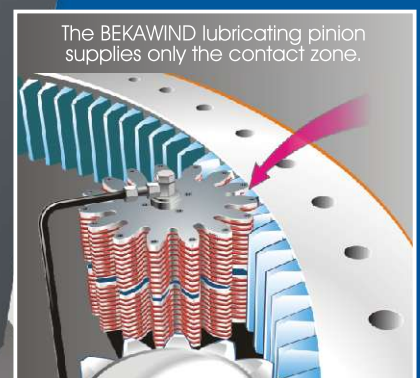

BEKAWIND PRO The progressive system

BEKAWIND SINGLE



BEKAWIND PRO



BEKAWIND FLOW

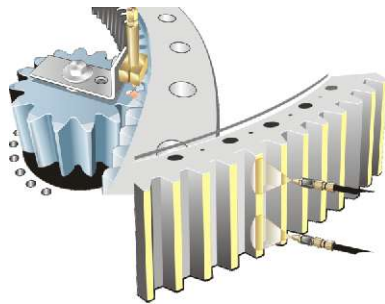

BEKAWIND COMBI

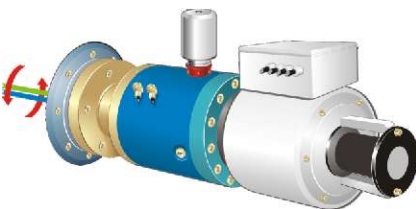

BEKAWIND RETROFIT

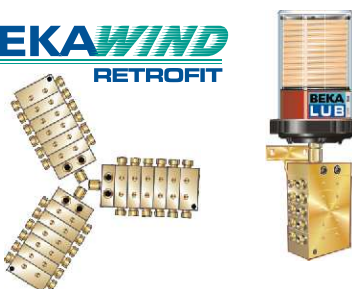

The single line system

- The solution for multi megawatt wind converters
- Ideal for offshore application
- High operational reliability at low ambient temperatures
- For all types of grease up to NLGI 2

The progressive system

- The flexible lubrication system with monitoring
- For oil and grease up to NLGI 2
- Modular design for easy service
- High functional reliability with blocking control

The solution with lubrication pinion

- The lubrication system for all kinds of toothings
- Lubrication only during intermeshing
- Suitable for lubricants with solids

The spray lubrication system

- Highly efficient contact-free technology
- Supply even during standstill of the tothing to avoid tribo corrosion
- Very low lubricant consumption
- No more pollution by overlubrication - no need for cleaning

The combined system

- Installation of all lubrication pumps in the nacelle
- Easy maintenance and refilling
- Easy retrofitting of elder converters
- Applicable for all BEKAWIND lubrication systems

Retrofitting solutions

- Tailor-made retrofitting solutions for wind converters
- From single nipple lubrication up to complete system
- Easy retrofitting of elder wind converters

Wind converters are subject to high mechanical loads. They have to work with absolute reliability. Break down due to lack of lubrication is an avoidable failure.

A central lubrication system continuously supplies fresh lubricant to the connected lube points. The right quantity at the right time.

That's why a reliable lubricant supply of a wind converter can only be realized with automatic lubrication systems.

CENTRAL LUBRICATION SYSTEMS FOR WIND CONVERTERS

The design of BEKAWIND central lubrication systems is adapted individually to each wind converter and its operating conditions. All important components like bearings, toothings and adjustment devices are supplied with precisely metered quantities of lubricant at the right time.

Depending on the application, different BEKAWIND systems are employed:

BEKAWIND SINGLE
the tried-and-tested single line system.

BEKAWIND
SINGLE

BEKAWIND PRO
the flexible progressive system.

BEKAWIND
PRO

BEKAWIND FLOW
the innovative spray lubrication system.

BEKAWIND
FLOW

BEKAWIND COMBI
complete supply from the nacelle.

BEKAWIND
COMBI

BEKAWIND RETRO
the retrofitting program.

BEKAWIND
RETROFIT



Design and layout of the central lubrication system are decisive for economic efficiency, service life and operational reliability of the whole wind converter.

The BEKAWIND specialists will be pleased to support you all around central lubrication!

BEKAWIND

Tailor-made central lubrication systems for wind converters.

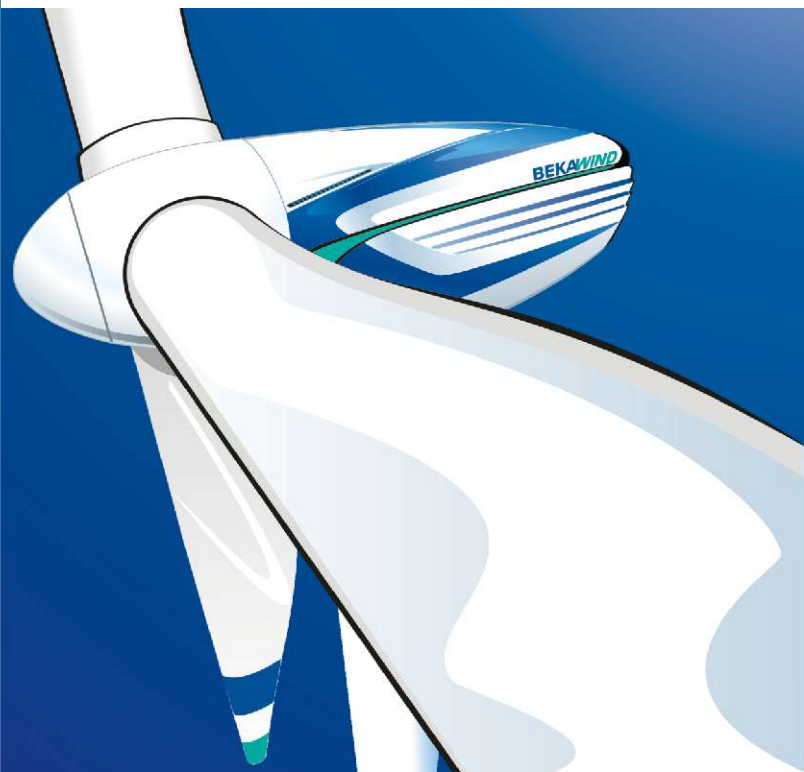

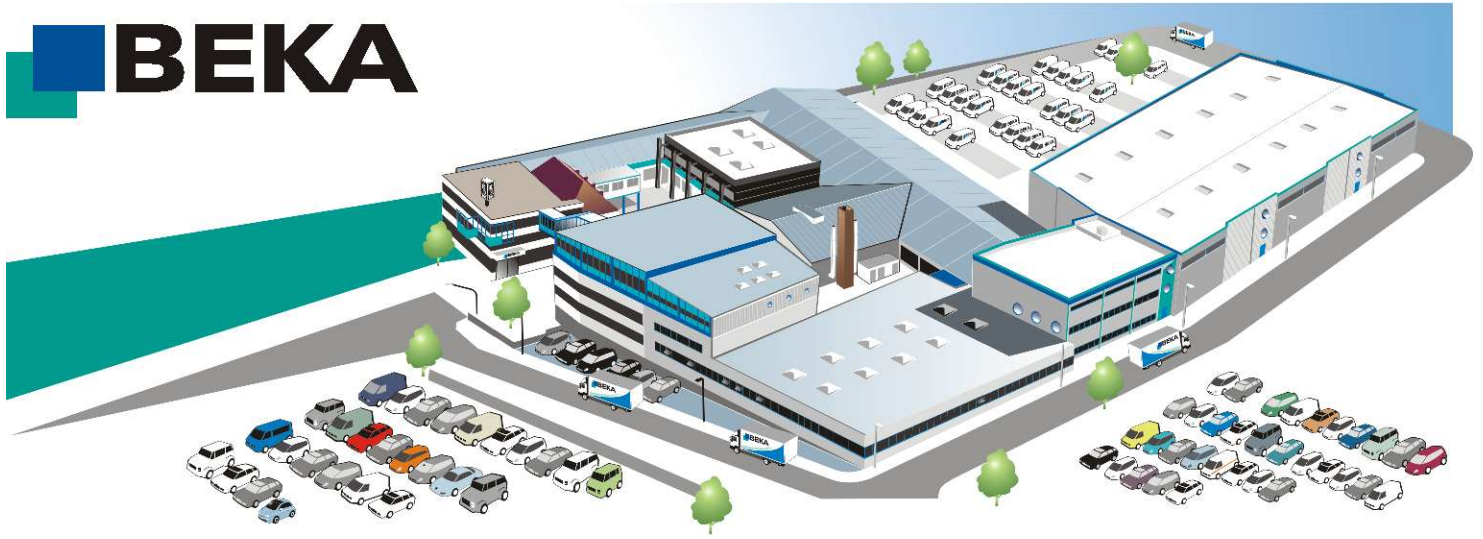

BAIER + KÖPPEL GMBH + CO KG
PRÄZISIONSAPPARATEFABRIK

BEETHOVENSTRASSE 14
91 257 PEGNITZ/BAVARIA

PO BOX 13 20
91 253 PEGNITZ/BAVARIA

GERMANY

fon +49 9241 729-0
fax +49 9241 729-50

e-mail beka@beka-lube.de
web www.beka-lube.de

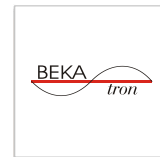
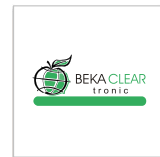

Partners

AUSTRIA

BEKA-Lube GmbH
Carola-Blome-Str. 7
5020 Salzburg
fon +43 662 43 84 40
fax +43 662 43 84 403
e-mail office@beka-lube.at

CHINA

EAST TSANHAIR COMPANY LTD.
7A Building, Medicine Valley No.1,
No.9 Tianfu Street, Bio-Medicine Park,
Zhongguancun Science Park,
Daxing District, Beijing, China 102600
fon +86 10 83 681 526
fax +86 10 83 681 520
e-mail beka-lube@bekachina.com

KOREA

BAIER + KÖPPEL Korea Liaison Office
A-1406, Sunyudo Woolim Lions Valley
Yangpyeong-dong 5-ga
Yeongdeungpo-gu, Seoul (150-984)
fon +82 2 2038 0988
fax +82 2 2038 8934
e-mail sales@bekaworld.kr

TURKEY

BEKAMAKS MAKINA SANAYI ve TICARET
LTD. STI, Kucukyali Ticaret Merkezi
B Blok No. 7 Girne Mah.
34852 Maltepe / Istanbul
fon +90 216 367 34 00
fax +90 216 367 33 85
e-mail info@bekamaks.com

BELGIUM

BEKA LUBE N.V.S.A.
Demerstraat 32
BE 3200 Aarschot
fon +32 16 64 09 26
fax +32 16 64 05 48
e-mail bekalube@skynet.be

FRANCE

BEKALUBE FRANCE
4, bis Rue de l'Artisanat
89100 Paron
fon +33 386 83 39 06
fax +33 386 65 52 24
e-mail contacts@bekalube.fr

NETHERLANDS

BEKA NEDERLAND B.V.
Wagenmakerij 11
4762 AV Zevenbergen
fon +31 168 37 15 38
fax +31 168 33 83 29
e-mail info@beka.nl

USA

BEKAWORLD LP
2775 North Hills Drive
Atlanta Georgia 30305 USA
fon +1 404 841 1133
fax +1 404 841 1196
cell +1 404 398 2165
e-mail s.pitman@bekaworld.co

CANADA

BEKA-LUBE Products Inc.
2830 Argenta Road, Unit 9
Mississauga ON L5N 8G4
fon +1 905 821 10 50
fax +1 905 858 05 97
e-mail info@beka-lube.com

ITALY

BEKALUBE s.r.l.
Via Rossi 152
20043 Arcore
fon +39 039 618 00 88
fax +39 039 61 75 23
e-mail bekalube@bekalube.it

SPAIN

BEKA-LUBE IBERICA S.L.
Avda. de Suiza, 3 P.A.L. Coslada
28820 Coslada (Madrid)
fon +34 91 670 78 00
fax +34 91 670 78 413
e-mail beka@beka-lube.es



Subsidiaries

Argentina	Great Britain	Latvia	Slovakia
Australia	Greece	Lithuania	Slovenia
Belarus	Hong Kong	Luxemburg	South Africa
Bosnia	Hungaria	Malaysia	Sweden
Brazil	India	New Zealand	Switzerland
Croatia	Indonesia	Norway	USA
Czechia	Iceland	Poland	and others
Denmark	Ireland	Portugal	
Estonia	Japan	Russia	
Finland	Korea	Serbia	